

# HP Photosmart C8100 All-in-One series

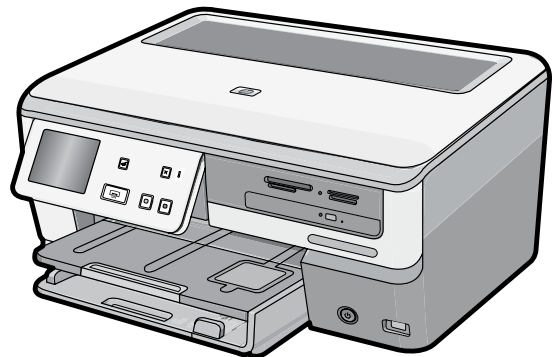

## Basics Guide



## **Hewlett-Packard Company notices**

The information contained in this document is subject to change without notice.

All rights reserved. Reproduction, adaptation, or translation of this material is prohibited without prior written permission of Hewlett-Packard, except as allowed under copyright laws. The only warranties for HP products and services are set forth in the express warranty statements accompanying such products and services. Nothing herein should be construed as constituting an additional warranty. HP shall not be liable for technical or editorial errors or omissions contained herein.

© 2007 Hewlett-Packard Development Company, L.P.

Windows, Windows 2000, and Windows XP are U.S. registered trademarks of Microsoft Corporation.

Windows Vista is either a registered trademark or trademark of Microsoft Corporation in the United States and/or other countries.

Intel and Pentium are trademarks or registered trademarks of Intel Corporation or its subsidiaries in the United States and other countries.

The Bluetooth trademarks are owned by its proprietor and used by Hewlett-Packard Company under license.

# Contents

<b>1 HP All-in-One overview</b>	
The HP All-in-One at a glance.....	2
Control panel features.....	3
Find more information.....	4
Use the Roxio Creator Basic Software.....	4
<b>2 Network setup</b>	
Wired network setup.....	5
Integrated wireless WLAN 802.11 network setup.....	7
Wireless ad hoc network setup.....	10
Install the software for a network connection.....	14
Connect to additional computers on a network.....	15
Change the HP All-in-One from a USB connection to a network connection.....	15
Manage your network settings.....	16
<b>3 Use the HP All-in-One features</b>	
Load originals and load paper.....	19
View, select, and print photos.....	22
Preserve your photos on CD/DVD and label the disc.....	23
Scan an image.....	24
Make a copy.....	25
Check the estimated ink levels.....	26
Replace the ink cartridges.....	26
<b>4 Troubleshooting and support</b>	
Uninstall and reinstall the software.....	29
Hardware setup troubleshooting.....	29
Network troubleshooting.....	31
Clear paper jams.....	35
Information on ink cartridges and the print head.....	37
Support process.....	37
<b>5 Technical information</b>	
System requirements.....	38
Product specifications.....	38
Energy Star® notice.....	38
Ink cartridge yield.....	39
Regulatory notices.....	39
Warranty.....	40

# 1 HP All-in-One overview

Use the HP All-in-One to quickly and easily accomplish tasks such as printing photos from a memory card, burning and labeling CD/DVDs, scanning documents, or making a copy. You can access many HP All-in-One functions directly from the control panel, without turning on your computer.

 **NOTE:** This guide introduces basic operations and troubleshooting, as well as provides information for contacting HP support and ordering supplies.

The onscreen Help details the full range of features and functions, including use of the HP Photosmart software that came with the HP All-in-One.

## The HP All-in-One at a glance

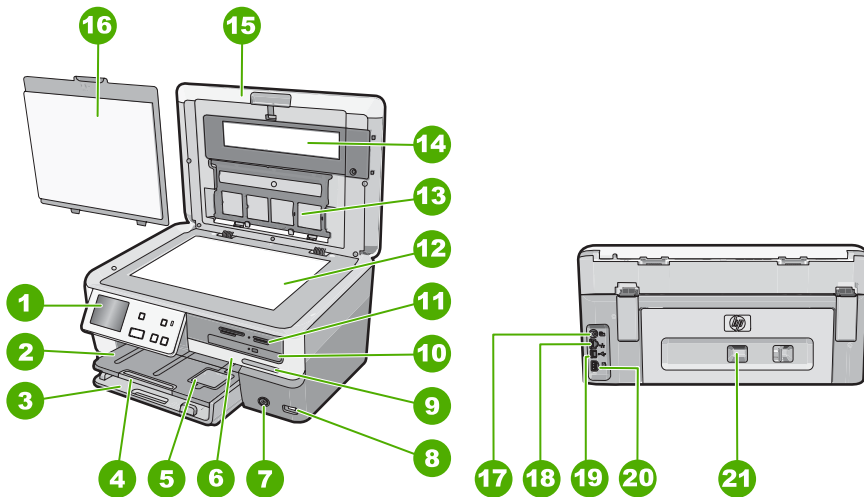

Label	Description
1	Control panel
2	Output tray
3	Main input tray (also referred to as the input tray)
4	Paper tray extender (also referred to as the tray extender)
5	Photo tray
6	Ink cartridge door
7	On button

(continued)

Label	Description
8	Front USB port
9	Wireless network indicator and Bluetooth light
10	LightScribe CD/DVD drive
11	Memory card slots and Photo light
12	Glass
13	Slide and Negative Film holder
14	Slide and Negative Film light
15	Lid
16	Lid backing
17	Slide and Negative Film light power port
18	Ethernet port
19	Rear USB port
20	Power connection*
21	Rear door

\* Use only with the power adapter supplied by HP.

## Control panel features

The following diagram and related table provide a quick reference to the HP All-in-One control panel features.

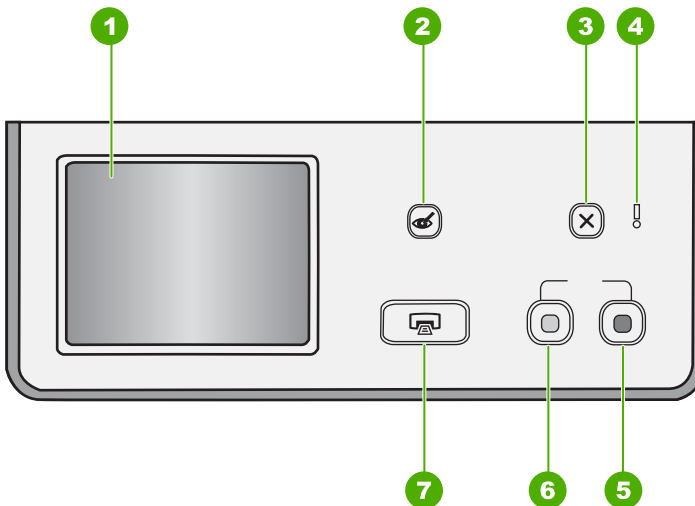

Label	Name and Description
1	<b>Display:</b> The touch screen display shows menus, photos, and messages. The control panel can be pulled up and angled for better viewing of this display.
2	<b>Red Eye Removal:</b> Turns the <b>Red Eye Removal</b> feature On or Off. By default, this feature is turned off. When the feature is turned on, the HP All-in-One automatically corrects red eye coloring in the photo currently shown on the display.
3	<b>Cancel:</b> Stops the current operation and returns to the main screen.
4	<b>Attention light:</b> Indicates a problem occurred. See the display for more information.
5	<b>Start Copy Color:</b> Starts a color copy.
6	<b>Start Copy Black:</b> Starts a black-and-white copy.
7	<b>Print Photos:</b> Depending on whether you access your photos from the <b>View</b> , <b>Print</b> , or <b>Create</b> menu, the <b>Print Photos</b> button will display the <b>Print Preview</b> screen or it will print any selected photo(s). If no photos are selected, a prompt appears asking if you want to print all the photos on your card, storage device or CD/DVD.

## Find more information

A variety of resources, both printed and onscreen, provide information about setting up and using the HP All-in-One.

- **Setup Guide**

The Setup Guide provides instructions for setting up the HP All-in-One and installing software. Make sure you follow the steps in the Setup Guide in order.

If you have problems during setup, see Troubleshooting in the last section of the Setup Guide, or see "[Troubleshooting and support](#)" on page 29 in this guide.

- **Onscreen Help**

The onscreen Help provides detailed instructions on features of the HP All-in-One that are not described in this Basics Guide, including features that are only available using the software you installed with the HP All-in-One.

- [www.hp.com/support](http://www.hp.com/support)

If you have Internet access, you can get help and support from the HP Web site. This Web site offers technical support, drivers, supplies, and ordering information.

## Use the Roxio Creator Basic Software

You can install the Roxio Creator Basic software that came with the HP All-in-One. This software lets you create and print text, photos, and pre-set designs on a LightScribe disc to identify the contents of your CD or DVD. In addition, you can use the Roxio Creator Basic software to create and burn photo slide shows, music, and more onto a CD/DVD loaded in the LightScribe-enabled drive on the HP All-in-One. For information on using the Roxio Creator Basic software, see the help that came with the software.

 **NOTE:** Roxio software is available for USB connections only, and cannot be used in a network setup.

## 2 Network setup

This section describes how to connect the HP All-in-One to a network and how to view and manage network settings.

If you want to:	See this section:
Connect to a wired (Ethernet) network.	<a href="#">“Wired network setup”</a> on page 5
Connect to a wireless network with a wireless router (infrastructure).	<a href="#">“Integrated wireless WLAN 802.11 network setup”</a> on page 7
Connect directly to a wireless-capable computer without a wireless router (ad hoc).	<a href="#">“Wireless ad hoc network setup”</a> on page 10
Install the HP All-in-One software for use in a networked environment.	<a href="#">“Install the software for a network connection”</a> on page 14
Add connections to more computers on the network.	<a href="#">“Connect to additional computers on a network”</a> on page 15
Change the HP All-in-One from a USB connection to a network connection.  <b>NOTE:</b> Use the instructions in this section if you first installed the HP All-in-One with a USB connection, and you now want to change to either a wireless or Ethernet network connection.	<a href="#">“Change the HP All-in-One from a USB connection to a network connection”</a> on page 15
View or change the network settings.	<a href="#">“Manage your network settings”</a> on page 16
Find troubleshooting information.	<a href="#">“Network troubleshooting”</a> on page 31

 **NOTE:** You can connect the HP All-in-One to either a wireless or wired network, but not both at the same time.

### Wired network setup

This section describes how to connect the HP All-in-One to a router, switch, or hub using an Ethernet cable and how to install the HP All-in-One software for a network connection. This is known as a wired or Ethernet network.

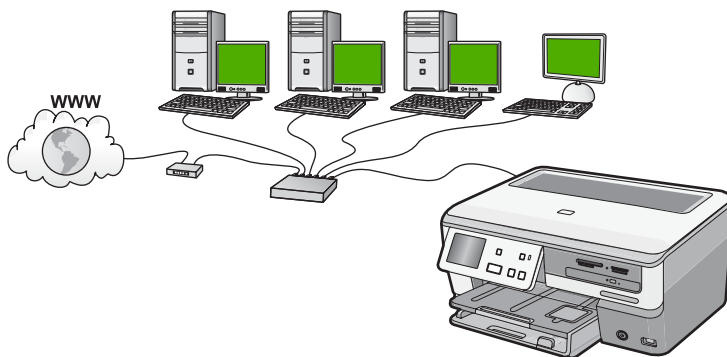

To set up the HP All-in-One on a wired network, you need to do the following:	See this section:
First, collect all of the required materials.	<a href="#">“What you need for a wired network”</a> on page 6
Next, connect to a wired network.	<a href="#">“Connect the HP All-in-One to the network”</a> on page 7
Finally, install the software.	<a href="#">“Install the software for a network connection”</a> on page 14

## What you need for a wired network

Before you connect the HP All-in-One to a network, make sure you have all of the required materials.

- A functional Ethernet network that includes a router, switch, or hub with an Ethernet port.
- CAT-5 Ethernet cable.

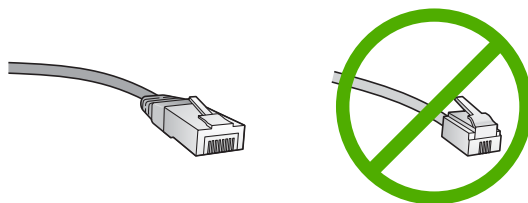

Although standard Ethernet cables look similar to standard telephone cables, they are not interchangeable. There is a different number of wires in each one, and each has a different connector. An Ethernet cable connector (also called an RJ-45 connector) is wider and thicker and always has 8 contacts on the end. A phone connector has between 2 and 6 contacts.

- A desktop computer or laptop with an Ethernet connection.

 **NOTE:** The HP All-in-One supports both 10 Mbps and 100 Mbps Ethernet networks. If you are purchasing, or have purchased, a network interface card (NIC), make sure it can operate at either speed.



## Connect the HP All-in-One to the network

To connect the HP All-in-One to the network, use the Ethernet port on the back of the device.

### To connect the HP All-in-One to the network

1. Remove the yellow plug from the back of the HP All-in-One.

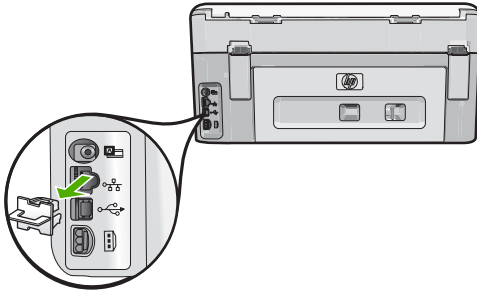

2. Connect the Ethernet cable to the Ethernet port on the back of the HP All-in-One.

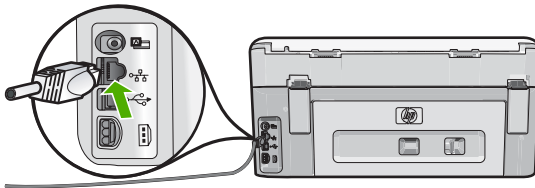

3. Connect the other end of the Ethernet cable to an available port on your Ethernet router, switch, or wireless router.

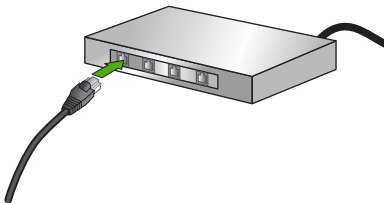

4. Once you have connected the HP All-in-One to the network, install the software as described in [“Install the software for a network connection”](#) on page 14.

## Integrated wireless WLAN 802.11 network setup

For optimal performance and security in your wireless network, HP recommends you use a wireless router or access point (802.11) to connect the HP All-in-One and the other network elements. When network elements are connected through a wireless router or access point, this is called an **infrastructure** network.

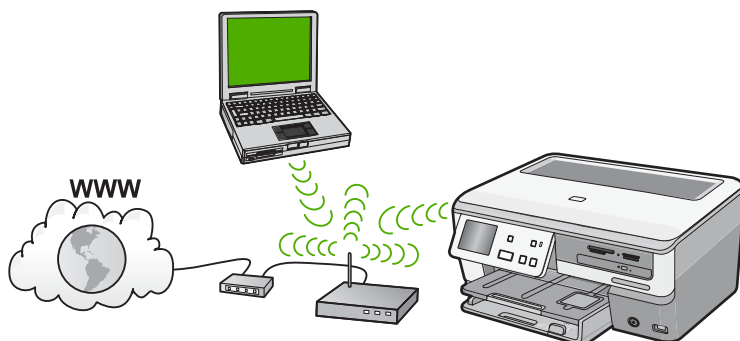

The advantages of a wireless infrastructure network as compared to an ad hoc network include:

- Advanced network security
- Enhanced reliability
- Network flexibility
- Better performance, especially with 802.11 g mode
- Shared Broadband Internet access

<b>To set up the HP All-in-One on an integrated wireless WLAN 802.11 network, you need to do the following:</b>	<b>See this section:</b>
First, collect all of the required materials.	<a href="#">“What you need for an integrated wireless WLAN 802.11 network” on page 8</a>
Next, connect the HP All-in-One to the wireless router, and run the Wireless Setup Wizard.	<a href="#">“Connect to an integrated wireless WLAN 802.11 network” on page 8</a>
Finally, install the software.	<a href="#">“Install the software for a network connection” on page 14</a>

## What you need for an integrated wireless WLAN 802.11 network

To connect the HP All-in-One to an integrated wireless WLAN 802.11 network, you will need the following:

- A wireless 802.11 network that includes a wireless router or access point.
- A desktop computer or laptop with either wireless networking support, or a network interface card (NIC). The computer must be connected to the wireless network that you intend to install the HP All-in-One on.
- If you connect the HP All-in-One on a wireless network that has Internet access, HP recommends that you use a wireless router (access point or base station) that uses Dynamic Host Configuration Protocol (DHCP).
- Network name (SSID).
- WEP key or WPA Passphrase (if needed).

## Connect to an integrated wireless WLAN 802.11 network

The Wireless Setup Wizard provides an easy way to connect the HP All-in-One to your network. You can also use SecureEasySetup, if your wireless router or access point

supports this feature. See the documentation that came with your wireless router or access point to find out if it supports using EasySetup and for additional setup instructions.

---

 **CAUTION:** To prevent other users from accessing your wireless network, HP strongly recommends using a password or passphrase (WPA or WEP security) and a unique network name (SSID) for your wireless router. Your wireless router might have been shipped with a default network name, which is typically the manufacturer name. If you use the default network name, your network can be easily accessed by other users using the same default network name (SSID). It also means that the HP All-in-One might accidentally connect to a different wireless network in your area which uses the same network name. If this happens you will not be able to access the HP All-in-One. For more information on how to change the network name, see the documentation that came with your wireless router.

 **NOTE:** Before connecting to a wireless infrastructure network, ensure that the ethernet cable is not connected to the HP All-in-One.

**NOTE:** HP provides an online tool that might be able to find your wireless security settings automatically. Go to: [www.hp.com/go/networksetup](http://www.hp.com/go/networksetup).

---

### To connect the HP All-in-One with the Wireless Setup Wizard

1. Write down the following information about your wireless router or access point:

- Network Name (also called SSID)
- WEP Key, WPA Passphrase (if needed)

If you do not know where to find this information, see the documentation that came with your wireless router or access point. You might be able to find the network name (SSID) and the WEP key or WPA passphrase on the Embedded Web Server for the wireless router.

---

 **NOTE:** HP provides an online tool that might be able to find your wireless security settings automatically. Go to: [www.hp.com/go/networksetup](http://www.hp.com/go/networksetup).

---

2. Touch **Setup** on the display.

3. Touch **Network**.

---

 **NOTE:** If the menu option you want is not visible on the screen, touch ▲ or ▼ to scroll through all the menu options.

---

4. Touch **Wireless Setup Wizard**.

This runs the **Wireless Setup Wizard**.

5. Touch the name of the network you wrote down in step 1.

### If you do not see your network name in the list

a. Touch **Enter a New Network Name (SSID)**.

The visual keyboard appears.

b. Enter the network name (SSID). Touch the appropriate letters or numbers on the visual keyboard.

---

 **NOTE:** You must enter the **exact** uppercase (capital) and lowercase (small) letters. Otherwise, the wireless connection will fail.

---

- c. When you have finished entering the new network name, touch **Done**, and then touch **OK**.  
If the HP All-in-One is unable to discover the network based on the network name you entered, you will be prompted to answer additional questions about your network, as described in steps d and e. Before continuing, move the HP All-in-One closer to the computer and run the Wireless Setup Wizard again to see if the HP All-in-One can discover your network automatically.

- d. Touch **Infrastructure**.

- e. Touch **WEP encryption** or **WPA encryption**.

If you do **not** want to use WEP encryption, touch **No, my network does not use encryption**. Go to step 7.

6. If prompted, enter your WPA or WEP key as follows:

- a. Touch the appropriate letters or numbers on the visual keyboard.

---

 **NOTE:** You must enter the **exact** uppercase (capital) and lowercase (small) letters. Otherwise, the wireless connection will fail.

---

- b. When you are finished entering the WPA or WEP key, touch **Done**.

- c. Touch **OK** to confirm.

The HP All-in-One will attempt to connect to the network. If a message says you entered an invalid WPA or WEP key, check the key you wrote down for your new network, follow the prompts to correct the key, and then try again.

7. When the HP All-in-One connects successfully to the network, install the software on each computer that will use the device over the network.

### To connect the HP All-in-One with SecureEasySetup

1. Activate SecureEasySetup on your wireless router or access point.
2. Touch **Setup** on the display.
3. Touch **Network**.

---

 **NOTE:** If the menu option you want is not visible on the screen, touch ▲ or ▼ to scroll through all the menu options.

---

4. Touch **Wireless Setup Wizard**.

5. Follow the onscreen prompts on the display to complete the connection.

6. When the HP All-in-One connects successfully to the network, go to your computer to install the software on each computer that will use the network.

---

 **NOTE:** If the connection fails, the wireless router or access point might have timed out after you activated SecureEasySetup. Repeat the above task, ensuring that you complete the steps on the control panel of the HP All-in-One immediately after pressing the button on the wireless router or access point.

---

## Wireless ad hoc network setup

Use this section if you want to connect the HP All-in-One to a wireless-capable computer without using a wireless router or access point.

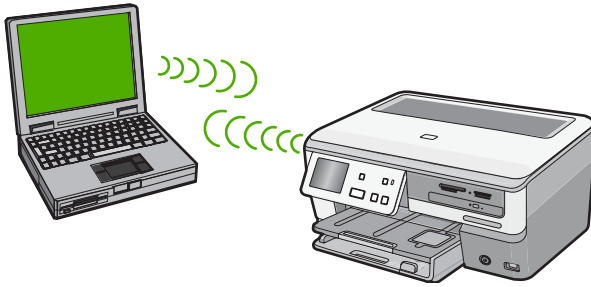

**NOTE:** An ad hoc connection is available if you do not have a wireless router or access point. However, it provides little flexibility, a low level of network security, and slower network performance than with a wireless router or access point.

In order to connect the HP All-in-One to your computer (ad hoc), you need to create an ad hoc network profile on your computer. This includes choosing a network name (SSID) and WEP security (optional but recommended) for your ad hoc network.

To set up the HP All-in-One on a wireless ad hoc network, you need to do the following:	See this section:
First, collect all of the required materials.	<a href="#">"What you need for an ad hoc network" on page 11</a>
Next, prepare your computer by creating a network profile.	<a href="#">"Create a network profile for a Windows XP computer" on page 11</a> <a href="#">"Create a network profile for other operating systems" on page 12</a>
Next, run the Wireless Setup Wizard.	<a href="#">"Connect to a wireless ad hoc network" on page 13</a>
Finally, install the software.	<a href="#">"Install the software for a network connection" on page 14</a>

## What you need for an ad hoc network

To connect the HP All-in-One to a wireless network, you will need a Windows computer with a wireless network adapter.

## Create a network profile for a Windows XP computer

Prepare your computer for an ad hoc connection by creating a network profile.

### To create a network profile

**NOTE:** The HP All-in-One comes configured with a network profile with **hpsetup** as the network name (SSID). However, for security and privacy HP recommends you create a new network profile on your computer as described here.

1. In the **Control Panel**, double-click **Network Connections**.
2. On the **Network Connections** window, right-click the **Wireless Network Connection**. If you see **Enable** on the pop-up menu, select it. Otherwise, if you see **Disable** on the menu, the wireless connection is already enabled.
3. Right-click the **Wireless Network Connection** icon, and then click **Properties**.
4. Click the **Wireless Networks** tab.
5. Select the **Use Windows to configure my wireless network settings** check box.
6. Click **Add**, and then do the following:
  - a. In **Network name (SSID)** box, type in a unique network name of your choice.

---

 **NOTE:** The network name is case sensitive, so it is important to remember any uppercase (capital) and lowercase (small) letters.

---

- b. If there is a **Network Authentication** list, select **Open**. Otherwise, go to the next step.
- c. In the **Data encryption** list, select **WEP**.

---

 **NOTE:** It is possible to create a network that does not use a WEP key. However, HP recommends using a WEP key in order to secure your network.

---

- d. Make sure that the check box is **not** selected next to **The key is provided for me automatically**. If it is selected, click the check box to clear it.
- e. In the **Network key** box, type a WEP key that has **exactly 5** or **exactly 13** alphanumeric (ASCII) characters. For example, if you enter 5 characters, you might enter **ABCDE** or **12345**. Or, if you enter 13 characters, you might enter **ABCDEF1234567**. (12345 and ABCDE are examples only. Select a combination of your choosing.)  
Alternatively, you can use HEX (hexadecimal) characters for the WEP key. A HEX WEP key must be 10 characters for 40 bit encryption, or 26 characters for 128 bit encryption.
- f. In the **Confirm network key** box, type the same WEP key you typed in the previous step.
- g. Write down the WEP key exactly as you typed it, including uppercase and lowercase letters.

---

 **NOTE:** You must remember the exact uppercase (capital) and lowercase (small) letters. If you enter your WEP key incorrectly on the HP All-in-One, the wireless connection will fail.

---

- h. Select the check box for **This is a computer-to-computer (ad hoc) network; wireless access points are not used**.
- i. Click **OK** to close the **Wireless network properties** window, and then click **OK** again.
- j. Click **OK** again to close the **Wireless Network Properties Connection** window.

## Create a network profile for other operating systems

If you have an operating system other than Windows XP, HP recommends that you use the configuration program that came with your wireless LAN card. To find the configuration program for your wireless LAN card, access your computer's list of programs.

Using the LAN card configuration program, create a network profile that has the following values:

- **Network name (SSID):** Mynetwork (example only)

---

 **NOTE:** You should create a network name that is unique and easy for you to remember. Just remember that the network name is case-sensitive. Therefore, you must remember which letters are uppercase and lowercase.

---

- **Communication mode:** Ad Hoc
- **Encryption:** enabled

## Connect to a wireless ad hoc network

You can use the Wireless Setup Wizard to connect the HP All-in-One to a wireless ad hoc network.

### To connect to a wireless ad hoc network

1. Touch **Setup** on the display.
2. Touch **Network**.

---

 **NOTE:** If the menu option you want is not visible on the screen, touch ▲ or ▼ to scroll through all the menu options.

---

3. Touch **Wireless Setup Wizard**.  
This runs the **Wireless Setup Wizard**. The setup wizard searches for available networks, and then displays a list of detected network names (SSIDs). The infrastructure networks appear first in the list, followed by available ad hoc networks. The networks with the strongest signal appear first, the weakest appear last.
4. On the display, look for the network name you created on your computer (for example, Mynetwork).
5. Touch the network name.  
If you found your network name and selected it, go on to step 6.

### If you do not see your network name in the list

- a. Touch **Enter a New Network Name (SSID)**.  
The visual keyboard appears.
- b. Enter the SSID. Touch the appropriate letters or numbers on the visual keyboard.

---

 **NOTE:** You must enter the **exact** uppercase (capital) and lowercase (small) letters. Otherwise, the wireless connection will fail.

---

- c. When you have finished entering the new SSID, touch **Done** on the visual keyboard, and then touch **OK**.  
If the HP All-in-One is unable to discover the network based on the network name you entered, you will be prompted to answer additional questions about your network, as described in steps d and e. Before continuing, move the HP All-in-One closer to the computer and run the Wireless Setup Wizard again to see if the HP All-in-One can discover your network automatically.
- d. Touch **Ad Hoc**.
- e. Touch **Yes, my network uses WEP encryption**. The visual keyboard displays. If you do **not** want to use WEP encryption, touch **No, my network does not use encryption**. Go to step 7.

6. If prompted, enter your WEP key as follows. Otherwise go to step 7.
  - a. Touch the appropriate letters or numbers on the visual keyboard.
 

---

 **NOTE:** You must enter the **exact** uppercase (capital) and lowercase (small) letters. Otherwise, the wireless connection will fail.

---
  - b. When you are finished entering the WEP key, touch **Done** on the visual keyboard.
7. Touch **OK** again to confirm.  
The HP All-in-One will attempt to connect to the SSID. If a message says you entered an invalid WEP key, check the key you wrote down for your new network, follow the prompts to correct the WEP key, and then try again.
8. When the HP All-in-One connects successfully to the network, go to your computer to install the software.

## Install the software for a network connection

Use this section to install the HP All-in-One software on a computer connected to a network. Before you install the software, make sure you have connected the HP All-in-One to a network.

 **NOTE:** If your computer is configured to connect to a series of network drives, make sure that your computer is currently connected to these drives before installing the software. Otherwise, HP All-in-One installation software might try to use one of the reserved drive letters, and you will not be able to access that network drive on your computer.

**NOTE:** Installation time can range from 20 to 45 minutes depending on your operating system, the amount of available space, and the processor speed of your computer.

### To install the Windows HP All-in-One software

1. Quit all applications running on your computer, including any virus detection software.
2. Insert the Windows CD that came with the HP All-in-One into the CD-ROM drive on your computer and follow the onscreen instructions.
3. If a dialog box about firewalls appears, follow the instructions. If you see firewall pop-up messages, you must always accept or allow the pop-up messages.
4. On the **Connection Type** screen, select **Through the network**, and then click **Next**.  
The **Searching** screen appears as the Setup program searches for the HP All-in-One on the network.
5. On the **Printer Found** screen, verify that the printer description is correct.  
If more than one printer is found on the network, the **Printers Found** screen appears. Select the HP All-in-One you want to connect.
6. Follow the prompts to install the software.  
When you have finished installing the software, the HP All-in-One is ready for use.
7. If you disabled any virus detection software on your computer, make sure to enable it again.
8. To test your network connection, go to your computer and print a self-test report to the HP All-in-One.



## Connect to additional computers on a network

You can share the HP All-in-One on a network so that more computers can use it. If the HP All-in-One is already connected to a computer on the network, you must install the HP All-in-One software on the network for each of the computers. During the installation, the software will discover the HP All-in-One on the network for each of the computers. Once you have set up the HP All-in-One on the network you will not need to configure it again when you add additional computers.

---

 **NOTE:** You can connect the HP All-in-One to either a wireless or wired network, but not both at the same time.

---

## Change the HP All-in-One from a USB connection to a network connection

If you first install the HP All-in-One with a USB connection, you can later change to either a wireless or Ethernet network connection. If you already understand how to connect to a network, you can use the general directions below.

---

 **NOTE:** For optimal performance and security in your wireless network, use an access point (such as a wireless router) to connect the HP All-in-One.

---

### To change a USB connection to an integrated wireless WLAN 802.11 connection

1. Unplug the USB connection from the back of the HP All-in-One.
2. Touch **Setup** on the display.
3. Touch **Network**.

---

 **NOTE:** If the menu option you want is not visible on the screen, touch ▲ or ▼ to scroll through all the menu options.

---

4. Touch **Wireless Setup Wizard**.  
This runs the **Wireless Setup Wizard**.
5. Install the software for a network connection, choose **Add a Device**, and then choose **Through the network**.
6. When the installation is complete, open **Printers and Faxes** (or **Printers**) in the **Control Panel** and delete the printers from the previous USB installation.

### To change a USB connection to a wired (Ethernet) connection

1. Unplug the USB connection from the back of the HP All-in-One.
2. Connect an Ethernet cable from the Ethernet port on the back of the HP All-in-One to an available Ethernet port on the router or switch.
3. Install the software for a network connection, choose **Add a Device**, and then choose **Through the network**.
4. When the installation is complete, open **Printers and Faxes** (or **Printers**) in the **Control Panel** and delete the printers from the previous USB installation.

For more detailed instructions on connecting the HP All-in-One to a network, see:

- “[Wired network setup](#)” on page 5
- “[Integrated wireless WLAN 802.11 network setup](#)” on page 7
- “[Wireless ad hoc network setup](#)” on page 10

## Manage your network settings

You can manage network settings for the HP All-in-One through the HP All-in-One control panel. Additional advanced settings are available in the Embedded Web Server, a configuration and status tool you access from your Web browser using an existing network connection to the HP All-in-One.

### Change basic network settings from the control panel

The HP All-in-One control panel enables you to set up and manage a wireless connection and to perform a variety of network management tasks. This includes viewing the network settings, restoring the network defaults, turning the wireless radio on and off, and changing the network settings.

#### Use the Wireless Setup Wizard

The Wireless Setup Wizard provides an easy way to set up and manage a wireless connection to the HP All-in-One.

1. Touch **Setup** on the display.
2. Touch **Network**.



**NOTE:** If the menu option you want is not visible on the screen, touch ▲ or ▼ to scroll through all the menu options.

---

3. Touch **Wireless Setup Wizard**.  
This runs the **Wireless Setup Wizard**.

#### View and print network settings

You can display a summary of the network settings on the HP All-in-One control panel, or you can print a more detailed configuration page. The network configuration page lists all of the important network settings such as the IP address, link speed, DNS, and mDNS.

1. Touch **Setup** on the display.
2. Touch **Network**.



**NOTE:** If the menu option you want is not visible on the screen, touch ▲ or ▼ to scroll through all the menu options.

---

3. Touch **View Network Settings** menu.
4. Do one of the following:
  - To display wired network settings, touch **Display Wired Summary**.
  - To display wireless network settings, touch **Display Wireless Summary**.
  - To print the network configuration page, touch **Print Network Configuration Page**.

### Restore network defaults

You can reset the network settings to what they were when you purchased the HP All-in-One.

---

△ **CAUTION:** This will erase all wireless setup information that you have entered. In order to restore this information, you will need to run the Wireless Setup Wizard again.

---

1. Touch **Setup** on the display.
2. Touch **Network**.

---

 **NOTE:** If the menu option you want is not visible on the screen, touch ▲ or ▼ to scroll through all the menu options.

---

3. Touch **Restore Network Defaults**.
4. Touch **Yes** or **No**.

### Turn the wireless radio on and off

In order to stay connected to a wireless network, the wireless radio must stay on. When the radio is on, the blue light on the front of the HP All-in-One is lit. However, if the HP All-in-One is connected to a wired network or you have a USB connection, the radio is not used. In this case you might want to turn the radio off.

1. Touch **Setup** on the display.
2. Touch **Network**.

---

 **NOTE:** If the menu option you want is not visible on the screen, touch ▲ or ▼ to scroll through all the menu options.

---

3. Touch **Wireless Radio**.
4. Touch **On** or **Off**.

### Print the wireless network test

The wireless network test performs a series of diagnostic tests to determine whether network setup is successful. If an issue is detected, a recommendation on how to correct the issue will be included on the printed report. You can print the wireless network test at any time.

1. Touch **Setup** on the display.
2. Touch **Network**.

---

 **NOTE:** If the menu option you want is not visible on the screen, touch ▲ or ▼ to scroll through all the menu options.

---

3. Touch **Wireless Network Test**.  
The **Wireless Network Test** prints.

### Change advanced network settings from the control panel settings

The advanced network settings are provided for your convenience. However, unless you are an advanced user, you should not change any of these settings.

## Change IP settings

The default setting for the IP settings is **Automatic**, which sets the IP settings automatically. However, if you are an advanced user, you might want to manually change the IP address, subnet mask, or the default gateway. To see the IP address and subnet mask of the HP All-in-One, print a network configuration page from the HP All-in-One.

---

 **NOTE:** When manually entering an IP setting, you must already be connected to an active network, otherwise the setting will not stay when you exit from the menu.

 **CAUTION:** Be careful when manually assigning an IP address. If you enter an invalid IP address during the installation, your network components will not be able to connect with the HP All-in-One.

---

1. Touch **Setup** on the display.
2. Touch **Network**.

---

 **NOTE:** If the menu option you want is not visible on the screen, touch ▲ or ▼ to scroll through all the menu options.

---

3. Touch **Advanced Setup**.
4. Touch **IP Settings**.
5. Touch **Manual**.
6. Touch one of the following IP settings.
  - **IP Address**
  - **Subnet Mask**
  - **Default Gateway**

The visual keyboard appears on the display.

7. Use the visual keyboard to enter your IP settings.

# 3 Use the HP All-in-One features

This chapter includes information about how to use the HP All-in-One for basic operations. In addition, it provides instructions about how to load paper, view and select photos, save photos to CD/DVDs, label the CD/DVDs, and replace the ink cartridges.

## Load originals and load paper

You can load documents and photos on the glass to scan or copy them. Additionally, you can load slides or negatives in the Slide and Negative Film Holder to scan and then print them.

### Load originals

You can copy or scan original documents up to letter- or A4-size by loading them on the glass.

#### To load an original on the scanner glass

1. Lift the lid on the HP All-in-One.
2. Load your original print side down on the right front corner of the glass.

 **TIP:** For more help on loading an original, refer to the engraved guides along the edge of the glass.

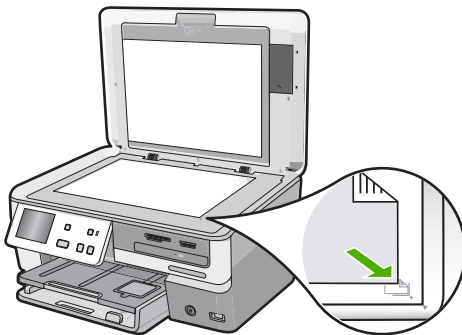

3. Close the lid.

### Load full-size paper

You can load many types of letter, A4, or legal paper into the main input tray of the HP All-in-One.

#### To load full-size paper

1. Pull out the main input tray, and then slide the paper-width and paper-length guides to their outermost positions.

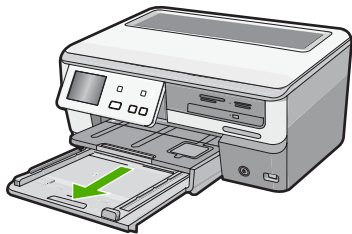

2. Tap a stack of paper on a flat surface to align the edges, and then check the paper for the following:
  - Make sure it is free of rips, dust, wrinkles, and curled or bent edges.
  - Make sure all the paper in the stack is the same size and type.
3. Insert the stack of paper into the main input tray with the short edge forward and the print side down. Slide the stack of paper forward until it stops.

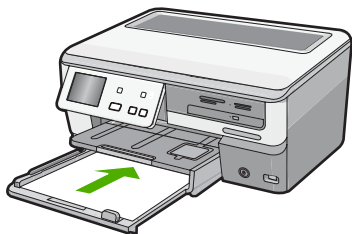

---

⚠ **CAUTION:** Make sure that the HP All-in-One is idle and silent when you load paper into the main input tray. If the HP All-in-One is servicing the ink cartridges or otherwise engaged in a task, the paper stop inside the device might not be in place. You could push the paper too far forward, causing the HP All-in-One to eject blank pages.

💡 **TIP:** If you are using letterhead, insert the top of the page first with the print side down. For more help on loading full-size paper and letterhead, refer to the diagram engraved in the base of the main input tray.

4. Slide the paper-width and paper-length guides inward until they stop at the edges of the paper.  
Do not overload the main input tray; make sure the stack of paper fits within the main input tray and is no higher than the top of the paper-width guide.

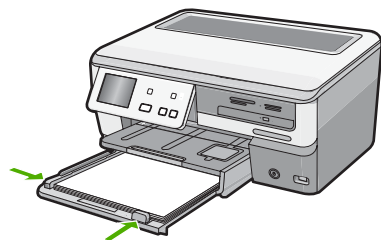

5. Push the main input tray back into the HP All-in-One.
6. Pull the output tray extender toward you, as far as it will go.

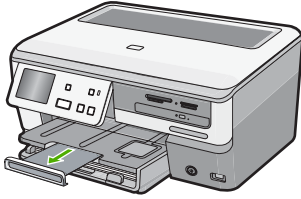

---

 **NOTE:** When you use legal-size paper, leave the tray extender closed.

---

### Load 10 x 15 cm (4 x 6 inch) photo paper

You can load up to 10 x 15 cm (4 x 6 inch) photo paper into the photo tray of the HP All-in-One. For the best results, use 10 x 15 cm (4 x 6 inch) HP Premium Plus Photo Paper or HP Premium Photo Paper.

#### To load up to 10 x 15 cm (4 x 6 inch) photo paper in the photo tray

1. Raise the output tray, and then pull out the photo tray.

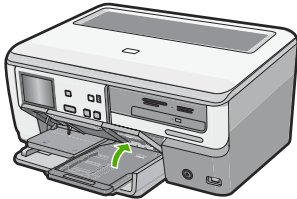

2. Insert the stack of photo paper into the photo tray with the short edge forward and the glossy side down. Slide the stack of photo paper forward until it stops.  
If the photo paper you are using has perforated tabs, load the photo paper so that the tabs are closest to you.
3. Slide the paper-length and paper-width guides inward against the stack of photo paper until the guides stop.  
Do not overload the photo tray; make sure the stack of photo paper fits within the photo tray and is no higher than the top of the paper-width guide.

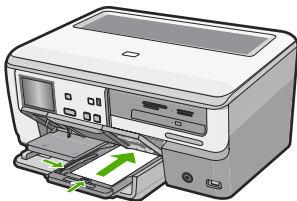

4. Push in the photo tray, and then lower the output tray.

## Avoid paper jams

To help avoid paper jams, follow these guidelines.

- Remove printed papers from the output tray frequently.
- Prevent curled or wrinkled paper by storing all unused paper flat in a resealable bag.
- Ensure that paper loaded in the input tray lays flat and the edges are not bent or torn.
- If you are printing labels, ensure that the label sheets are no more than two years old. Labels on older sheets might peel off when the paper is pulled through the HP All-in-One, and cause paper jams.
- Do not combine different paper types and paper sizes in the input tray; the entire stack of paper in the input tray must be the same size and type.
- Adjust the paper-width guide in the input tray to fit snugly against all paper. Make sure the paper-width guide does not bend the paper in the input tray.
- Do not force paper too far forward in the input tray.
- Use paper types that are recommended for the HP All-in-One.

## View, select, and print photos

You can view and select photos on your memory card, storage device, or CD/DVD before or while printing them.

### To view, select, and print photos

1. Insert a memory card into the appropriate slot on the HP All-in-One, connect a storage device to the front USB port, or insert a CD/DVD (label side up) into the LightScribe drive.

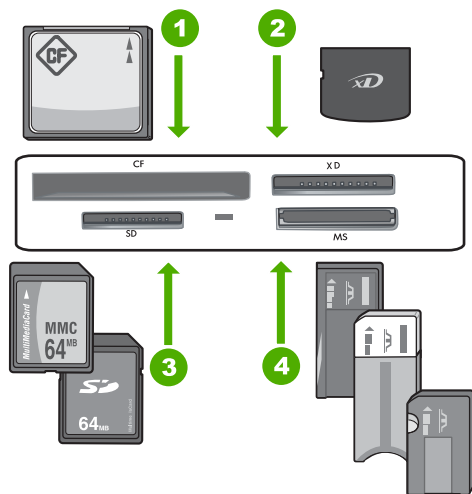

1	CompactFlash (CF) types I and II
2	xD-Picture Card
3	Secure Digital (SD), Secure Digital Mini (adapter required), Secure Digital High Capacity (SDHC), MultiMediaCard (MMC), MMC Plus, MMC Mobile (RS-MMC; adapter required), TransFlash MicroSD Card, or Secure MultiMedia Card



- 
- |   |  |
|---|--|
| 4 | Memory Stick, Memory Stick Pro, Memory Stick Select, Memory Stick Magic Gate, Memory Stick Duo or Duo Pro (adapter optional), or Memory Stick Micro (adapter required) |
|---|--|
- 

The **Photosmart Express** menu appears, with the most recent photo shown on the display.

2. Load up to 10 x 15 cm (4 x 6 inch) photo paper in the photo tray or full-size photo paper in the main input tray.
3. Touch **View**.  
The **View Photos** screen appears.
4. Touch ◀ or ▶ to scroll through the thumbnails of your photos.
5. When the thumbnail of the photo you want to view appears, touch it.
6. When the photo appears by itself on the display, touch the image again.  
The **Photo Options** screen appears.
7. Touch **Print Preview**.  
The **Print Preview** screen appears, showing how your photo will look when printed. If you want to select additional photos to view and print, touch **Add More** and repeat steps 4–6.
8. (Optional) If you want to check and/or modify any of your print settings, touch **Settings**.
9. To print the photo(s), touch **Print** or press the **Print Photos** button on the control panel.  
A print status screen displays the number of pages to print and the estimated time to complete.

## Preserve your photos on CD/DVD and label the disc

The HP All-in-One enables you to save photos onto a CD/DVD, read the contents of a CD/DVD so you can view and print photos from the control panel on the HP All-in-One or transfer the photos to a connected computer, and add a text label to a LightScribe-compatible CD/DVD.

### To save your photos to a CD or DVD

1. Load a CD or DVD (label side up) in the LightScribe drive of the HP All-in-One.

---

 **NOTE:** If you plan to create a LightScribe text label that you can print on the CD/DVD, make sure the CD or DVD that you insert into the drive is a LightScribe disc.

---

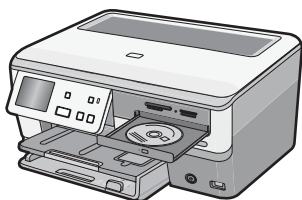

2. Insert a memory card into the appropriate slot on the HP All-in-One, or connect a storage device to the front USB port.  
The **Photosmart Express** menu appears, with the most recent photo shown on the display.
3. Touch **Save**.  
The **Save Photos** menu appears.
4. Touch **Save to CD/DVD**.  
When the photos have been saved to the CD or DVD, the **Photosmart Express** menu appears.

---

 **TIP:** You can also save photos to a CD or DVD by touching **CD/DVD** on the main screen, then choosing **Backup Memory Card** in the **LightScribe CD/DVD** menu.

---

### To create a LightScribe disc label

1. On the **Photosmart Express** menu, touch **Create**.
2. On the **Create** screen, touch ◀ or ▶ to scroll through the projects until you find **LightScribe Labeling**, then touch this project.
3. When prompted, load a LightScribe CD or DVD with the label side down.

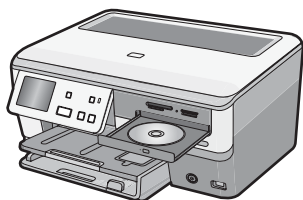

The visual keyboard appears.

4. Use the visual keyboard to enter titles and subtitles that identify your CD or DVD, and touch **Done** on the visual keyboard when you are finished.
5. In the **Label Summary** screen, touch **Burn**.  
At the printing status screen, touch **Return to Main Menu** to continue with any non-disc tasks while disc labeling continues in the background.

For more information on how to read or burn a CD/DVD, or use the LightScribe functions see the onscreen Help.

## Scan an image

You can start a scan from your computer or from the control panel of the HP All-in-One. This section explains how to scan from the control panel of the HP All-in-One only.

---

 **NOTE:** You can also use the software you installed with the HP All-in-One to scan images. Using this software, you can edit a scanned image and create special projects using a scanned image.

---

### Scan an original to a computer

You can scan originals placed on the glass by using the control panel.

### To scan to a computer

1. Load your original print side down on the right front corner of the glass.
2. Touch **Scan**.  
The **Scan Menu** appears.
3. Touch **Scan to Computer**.
4. If the HP All-in-One is connected directly to a computer with a USB cable, proceed to step 6.
5. If the HP All-in-One is connected to one or more computers on a network, do the following:
  - a. The **Select Computer** menu appears.
  - b. A list of the computers connected to the HP All-in-One appears on the display.
  - c. Touch the required destination computer name.



**NOTE:** The **Select Computer** menu might list computers with a USB connection in addition to those connected through the network.

---

6. The **Scan To** menu appears on the display, listing the applications on the computer.
7. Touch the appropriate computer application.  
A preview image of the scan appears on your computer, where you can edit it.
8. Make any edits to the preview image, and then click **Accept** when you are finished.

### Scan an original to a memory card or storage device

You can send the scanned image as a JPEG image to the memory card that is currently inserted or a storage device that is currently attached to the front USB port. This enables you to use the photo print options to print borderless prints and album pages from the scanned image.



**NOTE:** If the HP All-in-One is connected to a network, you can access the scanned image only if the card or device is being shared across the network.

---

### To save a scan to a memory card or a memory device.

1. Make sure that either a memory card is inserted into the appropriate slot or a storage device is attached to the front USB port on the HP All-in-One.
2. Load your original print side down on the right front corner of the glass.
3. Touch **Scan**.  
The **Scan Menu** appears.
4. Touch **Scan to Memory Device**.  
The HP All-in-One scans the image and saves the file to the memory card or the storage device in the JPEG format.

## Make a copy

You can make quality copies from the control panel.

### To make a copy from the control panel

1. Make sure you have paper loaded in the input tray.
2. Load your original print side down on the right front corner of the glass.
3. Press **Start Copy Black** or **Start Copy Color** to begin copying.

## Check the estimated ink levels

You can easily check the ink supply level to determine how soon you might need to replace an ink cartridge. The ink supply level shows an estimate of the amount of ink remaining in the ink cartridges.

 **NOTE:** The HP All-in-One can only detect the ink levels for genuine HP ink. The ink levels in ink cartridges that are refilled or have been used in other devices might not register accurately.

**NOTE:** Ink from the cartridges is used in the printing process in a number of different ways, including in the initialization process, which prepares the device and cartridges for printing, and in printhead servicing, which keeps print nozzles clear and ink flowing smoothly. In addition, some residual ink is left in the cartridge after it is used. For more information, see [www.hp.com/go/inkusage](http://www.hp.com/go/inkusage).

### To check the ink levels from the control panel

1. Touch **Setup** on the display.
2. Touch **Tools**.
3. Touch **Display Ink Gauge**.

The HP All-in-One displays a gauge that shows the estimated ink levels of all cartridges installed.

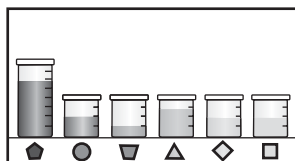

 **TIP:** You can also print a self-test report to see if ink cartridges might need to be replaced.

## Replace the ink cartridges

Follow these instructions when you need to replace ink cartridges.

 **NOTE:** If you are installing ink cartridges in the HP All-in-One for the first time, be sure to use only the ink cartridges that came with the device. The ink in these cartridges is specially formulated to mix with the ink in the print head assembly at first-time setup.

If you do not already have replacement ink cartridges for the HP All-in-One, you can order them by clicking the **Shop for HP Supplies** icon on your computer. On a Windows computer this is located in the **HP** folder in the **Start** menu.

For more information see [www.hp.com/buy/supplies](http://www.hp.com/buy/supplies).

### To replace the ink cartridges

1. Make sure the HP All-in-One is turned on.
2. Open the ink cartridge door by lifting from the front center of the device, until the door locks into place.

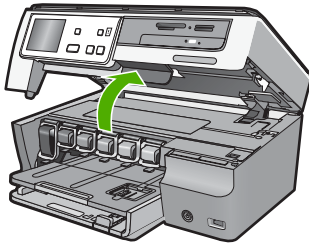

3. Squeeze the bottom of the latch below the ink cartridge you want to replace, and then lift the latch.

If you are replacing the black ink cartridge, lift the latch on the far left.

If you are replacing one of the five color ink cartridges, such as yellow, light cyan (blue), cyan, light magenta (pink), or magenta, lift the appropriate latch in the center area.

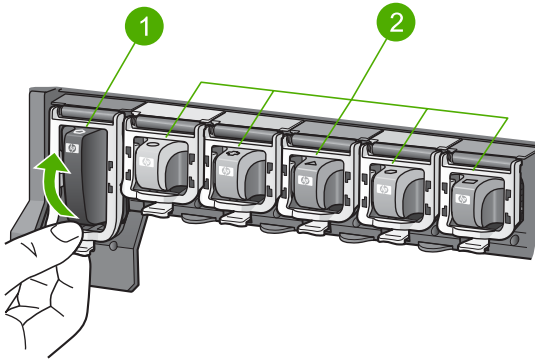

- |   |  |
|---|--|
| 1 | Ink cartridge latch for the black ink cartridge    |
| 2 | Ink cartridge latches for the color ink cartridges |

4. Pull the ink cartridge toward you out of its slot to remove it.

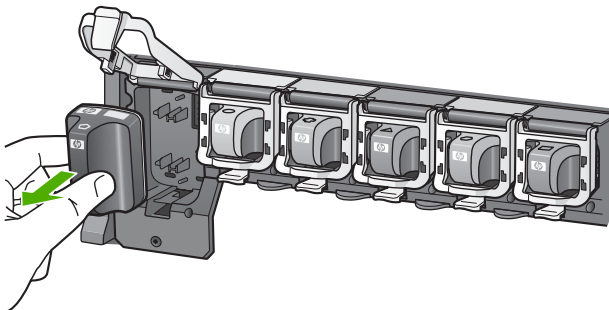

5. Remove the new ink cartridge from its packaging, and then, holding it by the handle, push the ink cartridge into the empty slot. Match the color and pattern of the ink cartridge to the color and pattern on the print carriage.

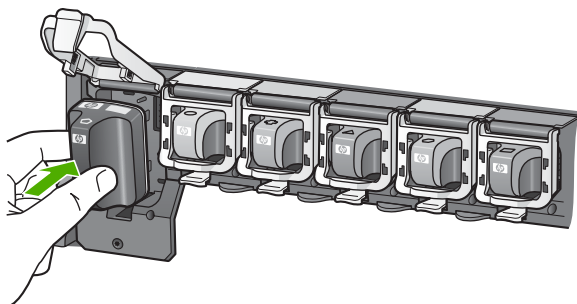

6. Close the latch and make sure it is secure.

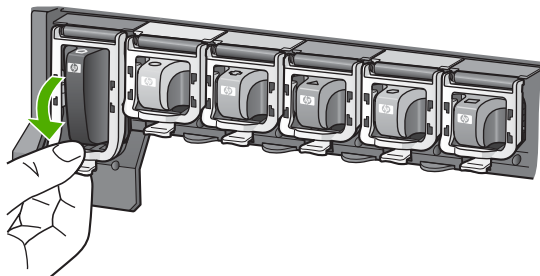

7. Repeat steps 3 through 6 for each ink cartridge you are replacing.
8. Close the ink cartridge door.

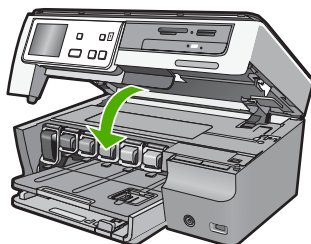

## 4 Troubleshooting and support

This chapter contains troubleshooting information for the HP All-in-One. Specific information is provided for installation and configuration issues, and some operational topics. For more troubleshooting information, see the onscreen Help that came with your software.

This chapter also provides warranty and support information. For support contact information, see the inside back cover of this guide.

Many issues are caused when the HP All-in-One is connected to the computer using a USB cable before the HP All-in-One software is installed on the computer. If you connected the HP All-in-One to your computer before the software installation screen prompts you to do so, you must follow these steps:

### Troubleshooting common setup issues

1. Disconnect the USB cable from the computer.
2. Uninstall the software (if you have already installed it).
3. Restart your computer.
4. Turn off the HP All-in-One, wait one minute, then turn it on.
5. Reinstall the HP All-in-One software.

---

 **CAUTION:** Do not connect the USB cable to the computer until prompted by the software installation screen.

---

### Uninstall and reinstall the software

If your installation is incomplete, or if you connected the USB cable to the computer before prompted by the software installation screen, you might need to uninstall and then reinstall the software. Do not simply delete the HP All-in-One application files from your computer. Make sure to remove them properly using the uninstall utility provided when you installed the software that came with the HP All-in-One.

#### To uninstall from a Windows computer and then reinstall

1. On the Windows taskbar, click **Start, Settings, Control Panel** (or just **Control Panel**).
2. Double-click **Add/Remove Programs** (or click **Uninstall a program**).
3. Select **HP Photosmart All-In-One Driver Software**, and then click **Change/Remove**. Follow the onscreen instructions.
4. Disconnect the HP All-in-One from your computer.
5. Restart your computer.

---

 **NOTE:** It is important that you disconnect the HP All-in-One before restarting your computer. Do not connect the HP All-in-One to your computer until after you have reinstalled the software.

---

6. Insert the HP All-in-One CD-ROM into your computer's CD-ROM drive and then start the Setup program.
7. Follow the onscreen instructions and the instructions provided in the Setup Guide that came with the HP All-in-One.

### Hardware setup troubleshooting

This section contains hardware troubleshooting information for the HP All-in-One.

This chapter also provides warranty and support information. For support contact information, see the inside back cover of this guide.

#### The HP All-in-One will not turn on

**Cause:** The HP All-in-One is not properly connected to a power supply.

**Solution**

- Make sure the power cord is firmly connected to both the HP All-in-One and the power adapter. Plug the power cord into a power outlet, surge protector, or power strip.

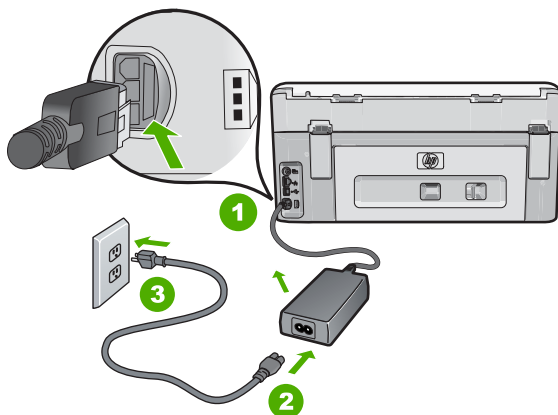

1	Power connection
2	Power cord and adapter
3	Power outlet

- If you are using a power strip, make sure the power strip is on. Or, try plugging the HP All-in-One directly into a power outlet.
- Test the power outlet to make sure it is working. Plug in an appliance that you know works, and see if the appliance has power. If not, then there might be a problem with the power outlet.
- If you plugged the HP All-in-One into a switched outlet, make sure the switch is on. If it is switched to on but still does not work, then there might be a problem with the power outlet.

**Cause:** You pressed the **On** button too quickly.

**Solution:** The HP All-in-One might not respond if you press the **On** button too quickly. Press the **On** button once. It might take a few minutes for the HP All-in-One to turn on. If you press the **On** button again during this time, you might turn the device off.

△ **CAUTION:** If the HP All-in-One still does not turn on, it might have a mechanical failure. Unplug the HP All-in-One from the power outlet and contact HP. Go to: [www.hp.com/support](http://www.hp.com/support). If prompted, choose your country/region, and then click **Contact HP** for information on calling for technical support.

### I connected the USB cable, but I am having problems using the HP All-in-One with my computer

**Cause:** The USB cable was connected before the software was installed. Connecting the USB cable before prompted can cause errors.

**Solution:** You must first install the software that came with the HP All-in-One before connecting the USB cable. During installation, do not plug in the USB cable until prompted by the onscreen instructions.

Once you have installed the software, connecting your computer to the HP All-in-One with a USB cable is straightforward. Simply plug one end of the USB cable into the back of your



computer and the other into the back of the HP All-in-One. You can connect to any USB port on the back of your computer.

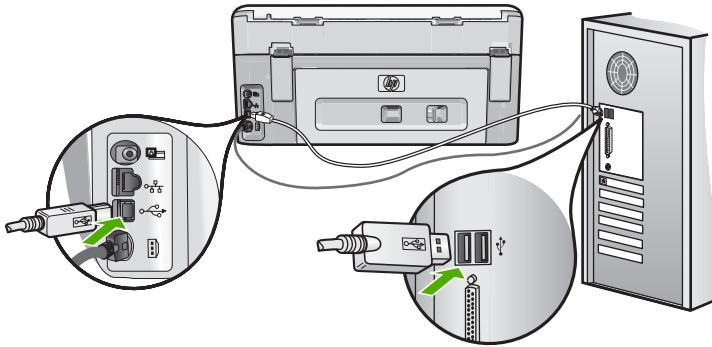

For more information on installing the software and connecting the USB cable, see the Setup Guide that came with the HP All-in-One.

### The HP All-in-One does not print

**Cause:** The HP All-in-One and computer are not communicating with each other.

**Solution:** Check the connection between the HP All-in-One and computer.

**Cause:** There might be a problem with one or more of the ink cartridges.

**Solution:** Check that the ink cartridges are installed properly and have ink.

**Cause:** The HP All-in-One might not be turned on.

**Solution:** Look at the display on the HP All-in-One. If the display is blank and the **On** button is not lit, the HP All-in-One is turned off. Make sure the power cord is firmly connected to the HP All-in-One and plugged into a power outlet. Press the **On** button to turn on the HP All-in-One.

**Cause:** The HP All-in-One might be out of paper.

**Solution:** Load paper in the input tray.

### The HP All-in-One has problems reading a CD/DVD

**Cause:** A dirty CD/DVD drive might cause read errors with CD/DVD discs.

**Solution:** To clean the CD/DVD-ROM, HP recommends that you purchase a CD-ROM cleaner from your local retailer. Using a CD-ROM cleaner should clean the CD-ROM laser from dust, dirt, and hair.

## Network troubleshooting

This section addresses problems you might encounter while setting up a network.

### Wired network setup troubleshooting

This section addresses problems you might encounter setting up a wired network.

#### The computer is unable to discover the HP All-in-One

**Cause:** Cables are not connected properly.

**Solution:** Check the following cables to ensure they are connected properly.

- Cables between the HP All-in-One and the hub or router
- Cables between the hub or router and your computer
- Cables to and from your modem or HP All-in-One Internet connection (if applicable)

**Cause:** Your computer's Local Area Network card (LAN card) is not set up properly.

**Solution:** Make sure that your LAN card is set up properly.

**To check your LAN card (Windows 2000 and XP)**

1. Right-click **My Computer**.
2. In the **System Properties** dialog box, click the **Hardware** tab.
3. Click **Device Manager**.
4. Make sure your card shows up under **Network Adapters**.
5. Refer to the documentation that came with your card.

**To check your LAN card (Windows Vista)**

1. On the Windows taskbar, click **Start, Computer**, and then click **Properties**.
2. Click **Device Manager**.
3. Make sure your card shows up under **Network Adapters**.
4. Refer to the documentation that came with your card.

**Cause:** You do not have an active network connection.

**Solution:** Check to see if you have an active network connection.

**To see if you have an active network connection**

- ▲ Check the two Ethernet indicator lights on the top and bottom of the RJ-45 Ethernet jack on the back of the HP All-in-One. The lights indicate the following:
  - a. Top light: If this light is a solid green, the device is properly connected to the network, and communications have been established. If the top light is off, there is no network connection.
  - b. Bottom light: This yellow light flashes when data is being sent or received by the device over the network.

**To establish an active network connection**

1. Check the cable connections from the HP All-in-One to your gateway, router, or hub to ensure connections are secure.
2. If the connections are secure, press the **On** button on the control panel to turn the HP All-in-One off. Then turn off the power on your router or hub. Turn on the router or hub first, and then press the **On** button to turn the HP All-in-One on.

**Cause:** You were able to connect the HP All-in-One to the network previously, but now it will not connect.

**Solution:** Turn off the HP All-in-One, the computer, and the router. Wait 30 seconds. Turn on the router first, and then turn on the HP All-in-One and the computer.

**Cause:** The HP All-in-One and computer are not connected to the same network.

**Solution:** Try accessing the Embedded Web Server on the HP All-in-One. To find the IP address, print a network configuration page.

## The Printer not Found screen appears during installation

**Cause:** The HP All-in-One is not turned on.

**Solution:** Turn on the HP All-in-One.

**Cause:** You do not have an active network connection.

**Solution:** Make sure you have an active network connection.

**To make sure your network connection is active**

1. If the connections are secure, turn off the power on the HP All-in-One, and then turn it on again. Press the **On** button on the control panel to turn the HP All-in-One off, and press it again to turn the device on. Also, turn off the power on your router or hub, and then turn it on again.
2. Check the cable connections from the HP All-in-One to your gateway, router, or hub to ensure connections are secure.
3. Make sure the HP All-in-One is connected to the network with a CAT-5 Ethernet cable.

**Cause:** Cables are not connected properly.

**Solution:** Check the following cables to ensure they are connected properly:

- Cables between the HP All-in-One and the hub or router
- Cables between the hub or router and your computer
- Cables to and from your modem or HP All-in-One Internet connection (if applicable)

**Cause:** A firewall, anti-virus, or anti-spyware application is preventing the HP All-in-One from accessing your computer.

**Solution:** Uninstall the HP All-in-One software, and then reboot your computer. Temporarily disable anti-virus or anti-spyware applications, and then reinstall the HP All-in-One software. You can re-enable your anti-virus or anti-spyware applications after installation is complete. If you see firewall pop-up messages, you must always accept or allow the pop-up messages.

If the screen still appears, try uninstalling the HP All-in-One software, rebooting your computer, and temporarily disabling your firewall before reinstalling the HP All-in-One software. You can re-enable your firewall application after installation is complete. If you still see firewall pop-up messages, you must always accept or allow the pop-up messages.

For more information, see the documentation provided with the firewall software.

**Cause:** A Virtual Private Network (VPN) is preventing the HP All-in-One from accessing your computer.

**Solution:** Try temporarily disabling the VPN before proceeding with the installation.

 **NOTE:** The HP All-in-One is not accessible during VPN sessions. However, print jobs are saved in the print queue. When you exit the VPN session, print jobs in the print queue will be printed.

## Wireless setup troubleshooting

This section addresses problems you might encounter setting up a network. Check the device display for specific error messages.

### During wireless network setup you do not see the SSID (network name) displayed

**Cause:** Your wireless router is not broadcasting its network name (SSID) because the **Broadcast SSID** option is turned off.

**Solution:** Access the router's Embedded Web Server and turn on the **Broadcast SSID** option. See the user guide that came with your wireless router for information on how to access the Embedded Web Server and check the Broadcast SSID setting.

For more information, see:

["Connect to an integrated wireless WLAN 802.11 network" on page 8](#)

**Cause:** The wireless router (infrastructure) or computer (ad hoc) is too far from the HP All-in-One or there is interference.

**Solution:** In order to establish a good signal between the HP All-in-One and wireless router (infrastructure) or computer (ad hoc), you might have to experiment a bit. Assuming the equipment is functioning properly, try doing the following things separately or in combination:

- If there is a long distance between your computer or wireless router and the HP All-in-One, move them closer together.
- If there are metal objects (such as a metal bookcase or refrigerator) in the transmission path, clear the path between the HP All-in-One and the computer or wireless router.
- If a cordless telephone, microwave, or other device that emits radio signals transmitting at 2.4 GHz is nearby, move it farther away to reduce radio interference.
- If your computer or wireless router is near an external wall, move them away from the wall.

---

**Cause:** Your network name (SSID) may be at the bottom of the SSID list that is displayed when you install the HP All-in-One on a wireless network.

**Solution:** Touch ▼ to scroll to the bottom of the list. Infrastructure entries are listed first, ad hoc last.

---

**Cause:** An Ethernet cable is connected to the HP All-in-One.

**Solution:** When an Ethernet cable is plugged into the HP All-in-One, the wireless radio turns off. Unplug the Ethernet cable.

### Weak signal

**Cause:** The HP All-in-One is too far away from the wireless router or there is interference.

**Solution:** In order to establish a good signal between the HP All-in-One and wireless router, you might have to experiment a bit. Assuming the equipment is functioning properly, try doing the following things separately or in combination:

- If there is a long distance between your computer or wireless router and the HP All-in-One, move them closer together.
- If there are metal objects (such as a metal bookcase or refrigerator) in the transmission path, clear the path between the HP All-in-One and the computer or wireless router.
- If a cordless telephone, microwave, or other device that emits radio signals transmitting at 2.4 GHz is nearby, move it farther away to reduce radio interference.
- If your computer or wireless router is near an external wall, move them away from the wall.

### Cannot connect to network during setup

**Cause:** The equipment is not turned on.

**Solution:** Turn on the networked devices, such as the wireless router for an infrastructure network, or the computer for an ad hoc network. For more information on how to turn on the wireless router, see the documentation that came with your wireless router.

---

**Cause:** The HP All-in-One is not receiving a signal.

**Solution:** Move the wireless router and the HP All-in-One closer together. Then run the wireless setup again.

For more information, see:

[“Integrated wireless WLAN 802.11 network setup” on page 7](#)

---

**Cause:** If you manually entered your network name (SSID), you might have entered it incorrectly.

**Solution:** Run the wireless setup process again and enter your network name (SSID) carefully. Remember that the SSID is case-sensitive.

For more information, see:

[“Connect to an integrated wireless WLAN 802.11 network” on page 8](#)

**Cause:** The setting for MAC address filtering might be enabled on your wireless router.

**Solution:** Disable MAC address filtering on your wireless router until the HP All-in-One has successfully connected to your network. If you re-enable MAC address filtering on your wireless router, make sure the MAC address of the HP All-in-One is on the list of acceptable MAC addresses.

---

### Invalid WEP key during wireless setup

**Cause:** If you are using WEP security, you might have entered the WEP key incorrectly during the wireless setup process.

**Solution:** During the wireless setup process, you might have entered the WEP key incorrectly. Some wireless routers provide up to four WEP keys. The HP All-in-One uses the first WEP key (selected by the wireless router as the default WEP key). Run the wireless setup process again and be sure to use the first WEP key provided by the wireless router. Enter the WEP key exactly as it appears in the wireless router settings. The WEP key is case sensitive.

If you do not know the WEP key, see the documentation that came with your wireless router for information on how to access the router's Embedded Web Server. You can find the WEP key by logging onto the router's Embedded Web Server using a computer on the wireless network.

---

### Invalid passphrase during wireless setup

**Cause:** During the wireless setup process, you might have entered the WPA passphrase incorrectly.

**Solution:** Run the wireless setup process again and enter the correct passphrase. The passphrase is case-sensitive.

---

### The Printer Not Found screen appears during installation

**Cause:** A firewall, anti-virus, or anti-spyware application is preventing the HP All-in-One from accessing your computer.

**Solution:** Uninstall the HP All-in-One software, and then reboot your computer. Temporarily disable anti-virus or anti-spyware applications, and then reinstall the HP All-in-One software. You can re-enable your anti-virus or anti-spyware applications after installation is complete. If you see firewall pop-up messages, you must always accept or allow the pop-up messages.

If the screen still appears, try uninstalling the HP All-in-One software, rebooting your computer, and temporarily disabling your firewall before reinstalling the HP All-in-One software. You can re-enable your firewall application after installation is complete. If you still see firewall pop-up messages, you must always accept or allow the pop-up messages.

For more information, see the documentation provided with the firewall software.

---

**Cause:** A Virtual Private Network (VPN) is preventing the HP All-in-One from accessing your computer.

**Solution:** Temporarily disable the VPN before proceeding with the installation.

---

 **NOTE:** The HP All-in-One functionality will be limited during VPN sessions.

---

**Cause:** The HP All-in-One is not turned on.

**Solution:** Turn on the HP All-in-One.

---

## Clear paper jams

If the HP All-in-One has a paper jam, first check the rear door. If the jammed paper is not in the rear rollers, check the top door.

**To clear a paper jam from the rear door**

1. Turn off the HP All-in-One.
2. Press in the tab on the rear door to release the door. Remove the door by pulling it away from the HP All-in-One.

△ **CAUTION:** Trying to clear a paper jam from the front of the HP All-in-One can damage the print mechanism. Always access and clear paper jams through the rear door.

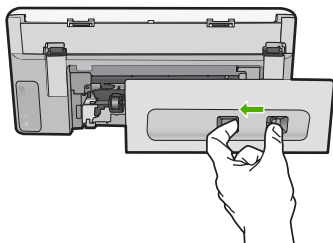

3. Gently pull the paper out of the rollers.

△ **CAUTION:** If the paper tears when you are removing it from the rollers, check the rollers and wheels for torn pieces of paper that might be remaining inside the device. If you do not remove all the pieces of paper from the HP All-in-One, more paper jams are likely to occur.

4. Replace the rear door. Gently push the door forward until it snaps into place.
5. Turn on the HP All-in-One, and then touch **OK** to continue the current job.

**To clear a paper jam from the top door**

1. Turn off the HP All-in-One.
2. Open the ink cartridge door.

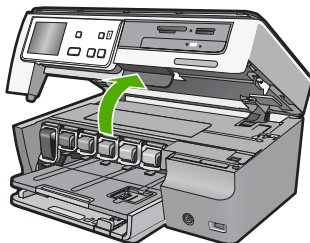

3. Lift the top door that is located behind the ink cartridges and print head assembly.

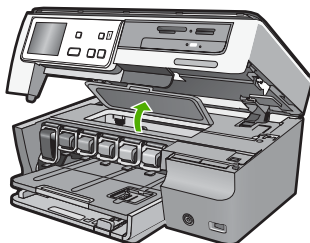

4. Gently pull the paper out of the rollers.

---

△ **CAUTION:** If the paper tears when you are removing it from the rollers, check the rollers and wheels for torn pieces of paper that might be remaining inside the device. If you do not remove all the pieces of paper from the HP All-in-One, more paper jams are likely to occur.

---

5. Close the top door.
6. Close the ink cartridge door.

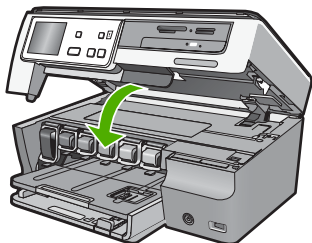

7. Turn on the HP All-in-One, and then touch **OK** to continue the current job.

## Information on ink cartridges and the print head

The following tips help maintain HP ink cartridges and ensure consistent print quality.

- Keep all ink cartridges in the original sealed packages until they are needed.
- Turn off the HP All-in-One from the control panel. Do not turn off the device by turning off a power strip or unplugging the power cord from the HP All-in-One. If you improperly turn off the HP All-in-One, the print head assembly might not return to the correct position.
- Store ink cartridges at room temperature (15.6°-26.6° C or 60°-78° F).
- HP recommends that you do not remove the ink cartridges from the HP All-in-One until you have replacement cartridges available to install. If you are transporting the HP All-in-One make sure you leave the ink cartridges installed to avoid ink leakage from the print head assembly.
- Clean the print head (via the Printer Toolbox Software maintenance) when you notice a significant decrease in print quality.
- Do not clean the print head unnecessarily. This wastes ink and shortens the life of the cartridges.
- Handle ink cartridges carefully. Dropping, jarring, or rough handling during installation can cause temporary printing problems.

## Support process

**If you have a problem, follow these steps:**

1. Check the documentation that came with the HP All-in-One.
2. Visit the HP online support Web site at [www.hp.com/support](http://www.hp.com/support). HP online support is available to all HP customers. It is the fastest source for up-to-date device information and expert assistance and includes the following features:
  - Fast access to qualified online support specialists
  - Software and driver updates for the HP All-in-One
  - Valuable HP All-in-One and troubleshooting information for common problems
  - Proactive device updates, support alerts, and HP newsgrams that are available when you register the HP All-in-One
3. Call HP support. Support options and availability vary by device, country/region, and language.

# 5 Technical information

The technical specifications and international regulatory information for the HP All-in-One are provided in this section.

## System requirements

Software system requirements are located in the Readme file.

## Product specifications

For product specifications, go to the HP Web site at [www.hp.com/support](http://www.hp.com/support).

### Paper specifications

- Main input tray capacity: Plain paper sheets: Up to 100 (20 lb./75 gsm. paper)
- Output tray capacity: Plain paper sheets: Up to 50 (20 lb./75 gsm. paper)
- Photo tray capacity: Photo paper sheets: Up to 20

---

 **NOTE:** For a complete list of supported media sizes, see the printer software.

---

### Physical specifications

- Height: 21.6 cm (8.5 inches)
- Width: 44.8 cm (17.6 inches)
- Depth: 38.8 cm (15.3 inches)
- Weight: 11.3 kg (25 pounds)

### Power specifications

- Power consumption: 25 watts maximum (average printing)
- Input voltage: AC 100 to 240 V ~ 600 mA 50–60 Hz
- Output voltage: DC 32 V===375 mA, 16 V===500 mA

---

 **NOTE:** Use only with the power adapter supplied by HP.

---

### Environmental specifications

- Recommended operating temperature range: 15° to 32° C (59° to 90° F)
- Allowable operating temperature range: 5° to 40° C (41° to 104° F)
- Humidity: 20% to 80% RH non-condensing
- Non-operating (Storage) temperature range: –20° to 60° C (–4° to 140° F)
- In the presence of high electromagnetic fields, it is possible the output from the HP All-in-One may be slightly distorted
- HP recommends using a USB cable less than or equal to 3 m (10 feet) in length to minimize injected noise due to potential high electromagnetic fields

## Energy Star® notice

This product is designed to reduce power consumption and save natural resources without compromising product performance. It has been designed to reduce total energy consumption both during operation and when the device is not active. This product qualifies for ENERGY STAR® which is a voluntary program established to encourage the development of energy-efficient office products.





ENERGY STAR is a U.S. registered service mark of the U.S. EPA. As an ENERGY STAR partner, HP has determined that this product meets ENERGY STAR guidelines for energy efficiency. For more information on ENERGY STAR guidelines, go to the following Web site:  
[www.energystar.gov](http://www.energystar.gov)

## Ink cartridge yield

Ink from the cartridges is used in the printing process in a number of different ways, including in the initialization process, which prepares the device and cartridges for printing, and in printhead servicing, which keeps print nozzles clear and ink flowing smoothly. In addition, some residual ink is left in the cartridge after it is used. For more information, see [www.hp.com/go/inkusage](http://www.hp.com/go/inkusage). Visit [www.hp.com/pageyield](http://www.hp.com/pageyield) for more information on estimated cartridge yields.

## Regulatory notices

The HP All-in-One meets product requirements from regulatory agencies in your country/region. For a complete listing of regulatory notices, see the onscreen Help.

### **Regulatory model identification number**

For regulatory identification purposes, your product is assigned a Regulatory Model Number. The Regulatory Model Number for your product is SDGOB-0712. This regulatory number should not be confused with the marketing name (HP Photosmart C8100 All-in-One series, etc.) or product numbers (L2523A, etc.).

# Warranty

HP product	Duration of limited warranty
Software Media	90 days
Printer	1 year
Print or Ink cartridges	Until the HP ink is depleted or the "end of warranty" date printed on the cartridge has been reached, whichever occurs first. This warranty does not cover HP ink products that have been refilled, remanufactured, refurbished, misused, or tampered with.
Accessories	1 year unless otherwise stated

## A. Extent of limited warranty

- Hewlett-Packard (HP) warrants to the end-user customer that the HP products specified above will be free from defects in materials and workmanship for the duration specified above, which duration begins on the date of purchase by the customer.
- For software products, HP's limited warranty applies only to a failure to execute programming instructions. HP does not warrant that the operation of any product will be interrupted or error free.
- HP's limited warranty covers only those defects that arise as a result of normal use of the product, and does not cover any other problems, including those that arise as a result of:
  - Improper maintenance or modification;
  - Software, media, parts, or supplies not provided or supported by HP;
  - Operation outside the product's specifications;
  - Unauthorized modification or misuse.
- For HP printer products, the use of a non-HP cartridge or a refilled cartridge does not affect either the warranty to the customer or any HP support contract with the customer. However, if printer failure or damage is attributable to the use of a non-HP or refilled cartridge or an expired ink cartridge, HP will charge its standard time and materials charges to service the printer for the particular failure or damage.
- If HP receives, during the applicable warranty period, notice of a defect in any product which is covered by HP's warranty, HP shall either repair or replace the product, at HP's option.
- If HP is unable to repair or replace, as applicable, a defective product which is covered by HP's warranty, HP shall, within a reasonable time after being notified of the defect, refund the purchase price for the product.
- HP shall have no obligation to repair, replace, or refund until the customer returns the defective product to HP.
- Any replacement product may be either new or like-new, provided that it has functionality at least equal to that of the product being replaced.
- HP products may contain remanufactured parts, components, or materials equivalent to new in performance.
- HP's Limited Warranty Statement is valid in any country where the covered HP product is distributed by HP. Contracts for additional warranty services, such as on-site service, may be available from any authorized HP service facility in countries where the product is distributed by HP or by an authorized importer.

## B. Limitations of warranty

TO THE EXTENT ALLOWED BY LOCAL LAW, NEITHER HP NOR ITS THIRD PARTY SUPPLIERS MAKES ANY OTHER WARRANTY OR CONDITION OF ANY KIND, WHETHER EXPRESS OR IMPLIED WARRANTIES OR CONDITIONS OF MERCHANTABILITY, SATISFACTORY QUALITY, AND FITNESS FOR A PARTICULAR PURPOSE.

## C. Limitations of liability

- To the extent allowed by local law, the remedies provided in this Warranty Statement are the customer's sole and exclusive remedies.
- TO THE EXTENT ALLOWED BY LOCAL LAW, EXCEPT FOR THE OBLIGATIONS SPECIFICALLY SET FORTH IN THIS WARRANTY STATEMENT, IN NO EVENT SHALL HP OR ITS THIRD PARTY SUPPLIERS BE LIABLE FOR DIRECT, INDIRECT, SPECIAL, INCIDENTAL, OR CONSEQUENTIAL DAMAGES, WHETHER BASED ON CONTRACT, TORT, OR ANY OTHER LEGAL THEORY AND WHETHER ADVISED OF THE POSSIBILITY OF SUCH DAMAGES.

## D. Local law

- This Warranty Statement gives the customer specific legal rights. The customer may also have other rights which vary from state to state in the United States, from province to province in Canada, and from country to country elsewhere in the world.
- To the extent that this Warranty Statement is inconsistent with local law, this Warranty Statement shall be deemed modified to be consistent with such local law. Under such local law, certain disclaimers and limitations of this Warranty Statement may not apply to the customer. For example, some states in the United States, as well as some governments outside the United States (including provinces in Canada), may:
  - Preclude the disclaimers and limitations in this Warranty Statement from limiting the statutory rights of a consumer (e.g., the United Kingdom);
  - Otherwise restrict the ability of a manufacturer to enforce such disclaimers or limitations; or
  - Grant the customer additional warranty rights, specify the duration of implied warranties which the manufacturer cannot disclaim, or allow limitations on the duration of implied warranties.
- THE TERMS IN THIS WARRANTY STATEMENT, EXCEPT TO THE EXTENT LAWFULLY PERMITTED, DO NOT EXCLUDE, RESTRICT, OR MODIFY, AND ARE IN ADDITION TO, THE MANDATORY STATUTORY RIGHTS APPLICABLE TO THE SALE OF THE HP PRODUCTS TO SUCH CUSTOMERS.

### HP Limited Warranty

Dear Customer,

You will find below the name and address of the HP entity responsible for the performance of the HP Limited Warranty in your country.

**You may have additional statutory rights against the seller based on your purchase agreement. Those rights are not in any way affected by this HP Limited Warranty.**

**Ireland:** Hewlett-Packard Ireland Ltd, 30 Herbert Street IRL-Dublin 2

**United Kingdom:** Hewlett-Packard Ltd, Cain Road, Bracknell, GB-Berks RG12 1HN



www.hp.com/support

021 672 280	الجزائر
Argentina (Buenos Aires)	54-11-4708-1600
Argentina	0-800-555-5000
Australia	1300 721 147
Australia (out-of-warranty)	1902 910 910
Österreich	www.hp.com/support
17212049	البحرين
België	www.hp.com/support
Belgique	www.hp.com/support
Brasil (Sao Paulo)	55-11-4004-7751
Brasil	0-800-709-7751
Canada	1-(800)-474-6836 (1-800 hp invent)
Central America & The Caribbean	www.hp.com/support
Chile	800-360-999
中国	10-68687980
中国	800-810-3888
Colombia (Bogotá)	571-606-9191
Colombia	01-8000-51-4746-8368
Costa Rica	0-800-011-1046
Česká republika	810 222 222
Danmark	www.hp.com/support
Ecuador (Andinatel)	1-999-119 ☎ 800-711-2884
Ecuador (Pacifitel)	1-800-225-528 ☎ 800-711-2884
(02) 6910602	مصر
El Salvador	800-6160
España	www.hp.com/support
France	www.hp.com/support
Deutschland	www.hp.com/support
Ελλάδα (από το εξωτερικό)	+ 30 210 6073603
Ελλάδα (εντός Ελλάδας)	801 11 75400
Ελλάδα (από Κύπρο)	800 9 2654
Guatemala	1-800-711-2884
香港特別行政區	(852) 2802 4098
Magyarország	06 40 200 629
India	1-800-425-7737
India	91-80-28526900
Indonesia	+62 (21) 350 3408
+971 4 224 9189	العراق
+971 4 224 9189	الكويت
+971 4 224 9189	لبنان
+971 4 224 9189	قطر
+971 4 224 9189	اليمن
Ireland	www.hp.com/support
1-700-503-048	ישראל
Italia	www.hp.com/support
Jamaica	1-800-711-2884
日本	0570-000511

日本(携帯電話の場合)	03-3335-9800
0800 222 47	الأردن
한국	1588-3003
Luxembourg	www.hp.com/support
Malaysia	1800 88 8588
Mauritius	(262) 262 210 404
México (Ciudad de México)	55-5258-9922
México	01-800-472-68368
081 005 010	المغرب
Nederland	www.hp.com/support
New Zealand	0800 441 147
Nigeria	(01) 271 2320
Norge	www.hp.com/support
24791773	عمان
Panamá	1-800-711-2884
Paraguay	009 800 54 1 0006
Perú	0-800-10111
Philippines	2 867 3551
Polska	22 5666 000
Portugal	www.hp.com/support
Puerto Rico	1-877-232-0589
República Dominicana	1-800-711-2884
Reunion	0820 890 323
România	0801 033 390
Россия (Москва)	095 777 3284
Россия (Санкт-Петербург)	812 332 4240
800 897 1415	السعودية
Singapore	6 272 5300
Slovensko	0850 111 256
South Africa (international)	+ 27 (0)11 234 5872
South Africa (RSA)	0860 104 771
Rest of West Africa	+ 351 213 17 63 80
Suomi	www.hp.com/support
Sverige	www.hp.com/support
Switzerland	www.hp.com/support
臺灣	02-8722-8000
ໄທ	+66 (2) 353 9000
071 891 391	تونس
Trinidad & Tobago	1-800-711-2884
Türkiye	+90 212 444 71 71
Україна	(044) 230-51-06
600 54 47 47	المتحدة العربية الإمارات
United Kingdom	www.hp.com/support
United States	1-(800)-474-6836
Uruguay	0004-054-177
Venezuela (Caracas)	58-212-278-8666
Venezuela	0-800-474-68368
Việt Nam	+84 88234530